

Ordering Code

Model No. T6DR (Y) - 022 - 1 L 00 - A 1 0 - A 1

Series

Y = Port flanges with metric threads

Cam ring

(Delivery at 0 bar & 1500 r.p.m.)

014 = 71,4 l/min	035 = 166,5 l/min
017 = 87,3 l/min	038 = 180,4 l/min
020 = 99,0 l/min	042 = 204,0 l/min
024 = 119,3 l/min	045 = 218,5 l/min
028 = 134,5 l/min	050 = 237,0 l/min
031 = 147,4 l/min	

Type of shaft

- 1 = keyed (SAE C)
- 2 = keyed (SAE CC)
- 3 = splined (SAE C)
- 5 = keyed (non SAE)

Direct. of rotation (view on shaft end)

- R = clockwise
- L = counter-clockwise

Porting combination

00 = standard

Modification

Seal class

- 1 = S1 (for mineral oil)
- 4 = S4 (for the resistant fluids)
- 5 = S5 (for mineral oil and fire resistant fluids)

Design letter

Porting adaptor

Coupling

- 1 = SAE A
- 2 = SAE B
- 3 = SAE BB
- 4 = SAE C
- 5 = SAE J498b
- 16/32 - 11 teeth

Adaptor

- 0 = None
- A = SAE A
- B = SAE B
- C = SAE C

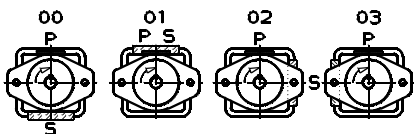

Porting adaptor

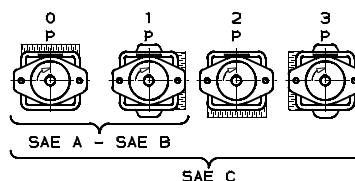

INTERNAL LEAKAGE (TYPICAL)

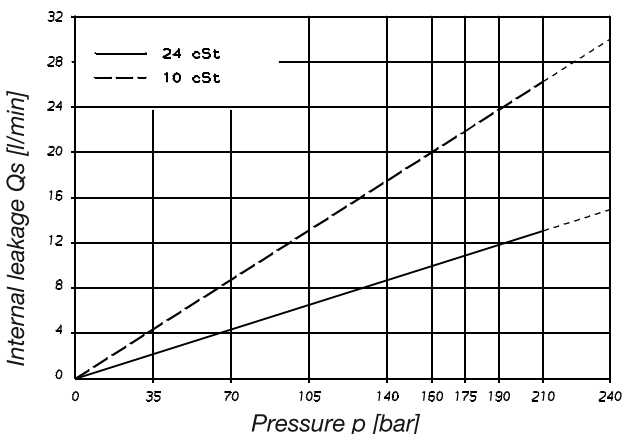

NOISE LEVEL (TYPICAL) - T6DR - 038

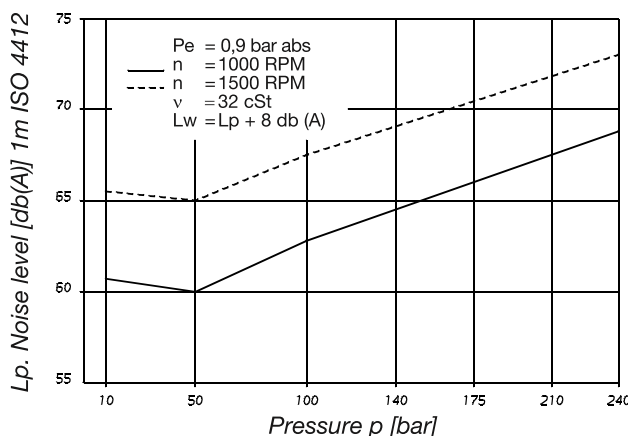

Do not operate the pump more than 5 seconds at any speed or viscosity if internal leakage is more than 50% of theoretical flow

POWER LOSS HYDROMECHANICAL (TYPICAL)

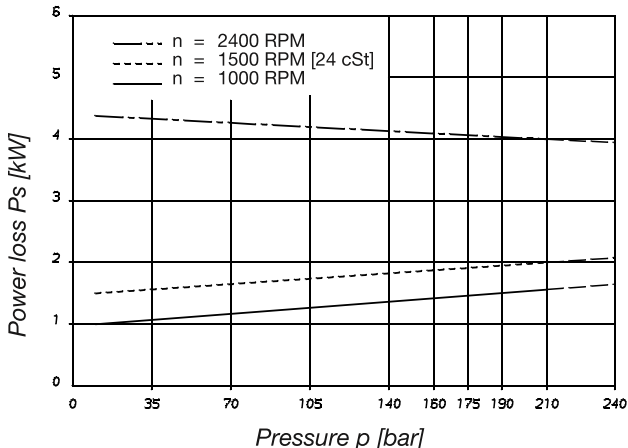

PERMISSIBLE RADIAL LOAD

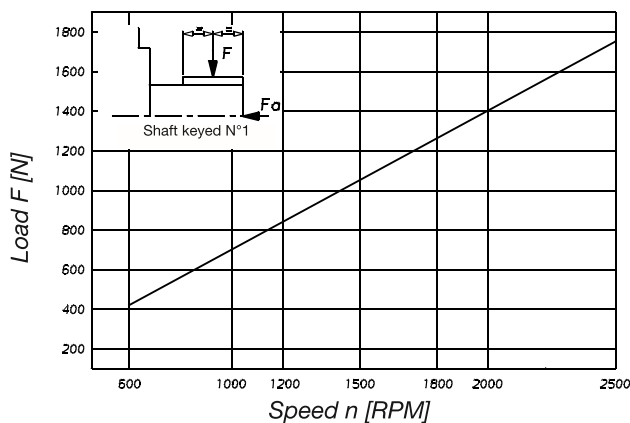

Maximum permissible axial load Fa = 1200 N

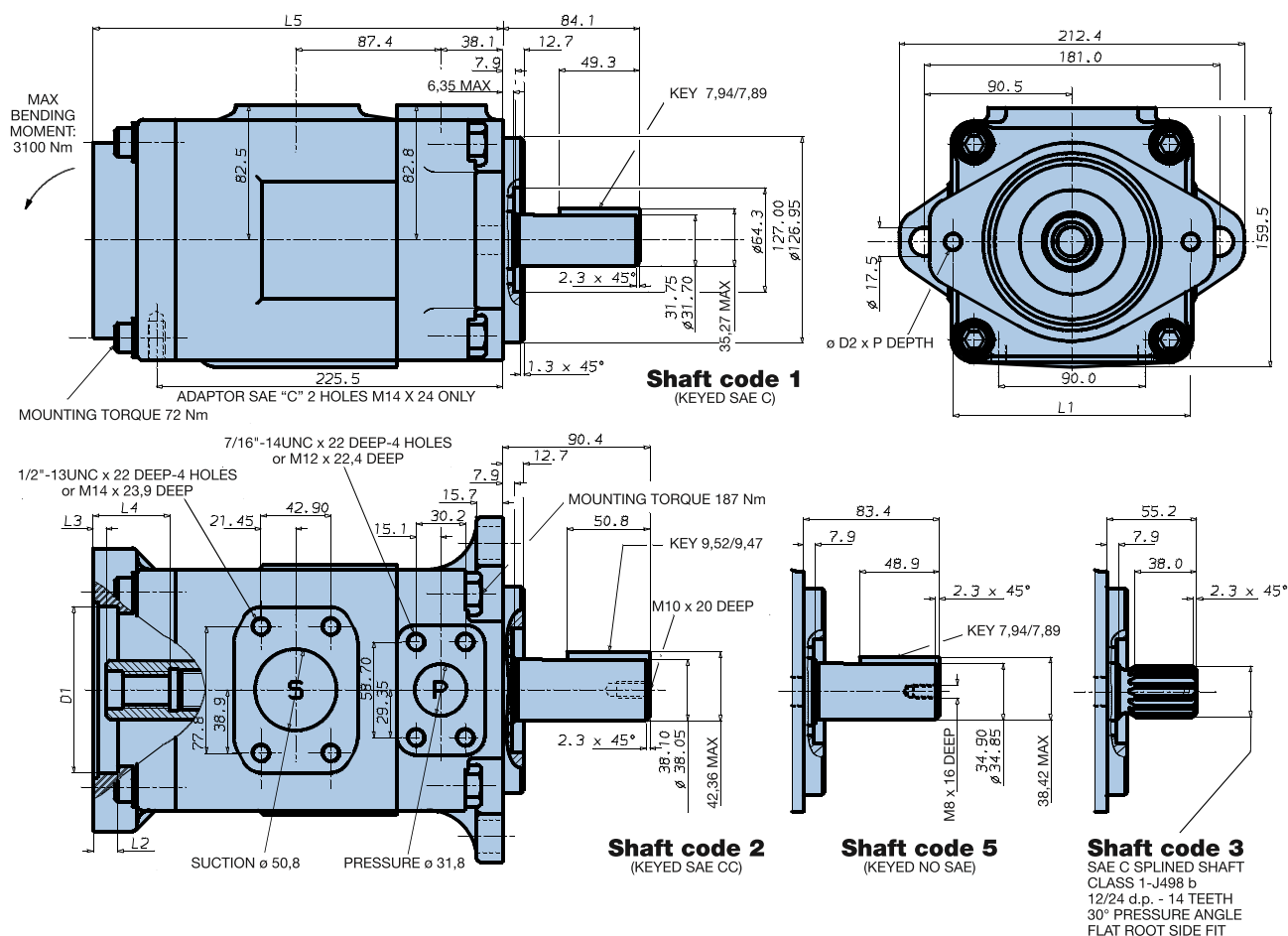

Adaptor	D1	D2	P	L1	L2	L3	L4	L5
SAE A	82,65/82,60	M10	24	106,4	11,0	8,0	32,0	237,0
SAE B	101,70/101,65	M12	28	146,0	16,0	8,0	46,0	251,0
SAE C	127,10/127,05	M16	-	181,0	16,0	8,0	56,0	261,0

Weight 32,3 kg

Adaptor	SAE A			SAE B		SAE C
	SAE A	SAE 11 teeth	SAE B	SAE B	SAE BB	SAE C
Coupling drive	SAE A	SAE 11 teeth	SAE B	SAE B	SAE BB	SAE C
Number of teeth	9	11	13	13	15	14
Pitch	16/32	16/32	16/32	16/32	16/32	12/24
Pressure angle	30°	30°	30°	30°	30°	30°
Major dia. (min)	15,875	19,05	22,225	22,225	25,400	31,750
Minor dia. (min)	12,700	16,017	19,134	19,134	22,268	27,589

Shaft torque limits [ml/rev x bar]			
Shaft	Vi x p max.	Coupling drive	Vi x p max.
1	43240	SAE A	11000
2	66036	SAE B	20600
3	61200	SAE BB	32670
5	55600	SAE C	37390
		SAE - 11 teeth	15850

OPERATING CHARACTERISTICS - TYPICAL [24 cSt]

Series	Volumetric Displacement Vi	Flow Q [l/min] & n = 1500 RPM			Input power P [kW] & n = 1500 RPM		
		p = 0 bar	p = 140 bar	p = 240 bar	p = 7 bar	p = 140 bar	p = 240 bar
014	47,6 ml/rev	71,4	62,1	55,9	2,3	18,5	30,6
017	58,2 ml/rev	87,3	78,0	71,8	2,5	22,2	37,0
020	66,0 ml/rev	99,0	89,7	83,5	2,8	24,9	41,7
024	79,5 ml/rev	119,3	110,0	103,8	3,0	29,6	49,8
028	89,7 ml/rev	134,5	125,2	119,0	3,2	33,2	55,9
031	98,3 ml/rev	147,4	138,1	131,9	3,3	36,2	61,1
035	111,0 ml/rev	166,5	157,2	151,0	3,5	40,7	68,7
038	120,3 ml/rev	180,4	171,1	164,9	3,7	43,9	74,3
042 ¹⁾	136,0 ml/rev	204,0	194,7	188,5	4,0	49,4	83,7
045 ¹⁾	145,7 ml/rev	218,5	209,2	203,0	4,1	52,8	89,5
050 ¹⁾	158,0 ml/rev	237,0	227,7	224,0 ²⁾	4,4	57,0	85,0 ²⁾

¹⁾ 042 - 045 - 050 = 2200 R.P.M. max.

²⁾ 050 = 210 bar max. int.

Port connection can be furnished with metric threads.