

F1-25-M kolbmootor, 37811724



Tootlikkus cm ³ /pöörde kohta	cm ³	25,6
--	-----------------	------

Maksimum pöörlemise kiirus	p/min
Pidev,	2300
Lühiajaline	3000

Maksimum töösurve	bar
Nominaal	250
Lühiajaline	350

Maksimum Nm	bar	Nm
	200	81
	350	142

Maksimum kW	kW
Pidev	20
Lühiajaline	26

Pöörlemise suund	R / L
------------------	-------

Kaal kg	8,5
---------	-----

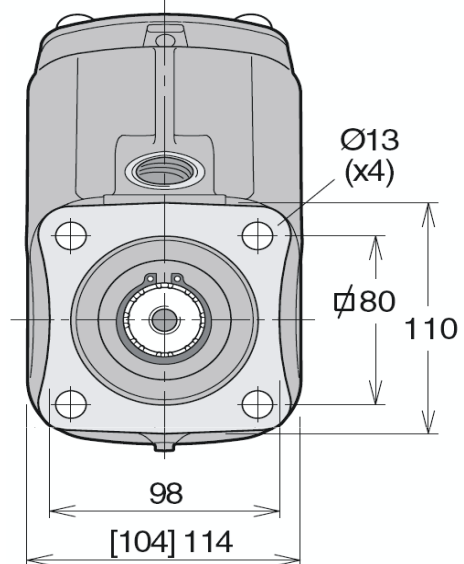
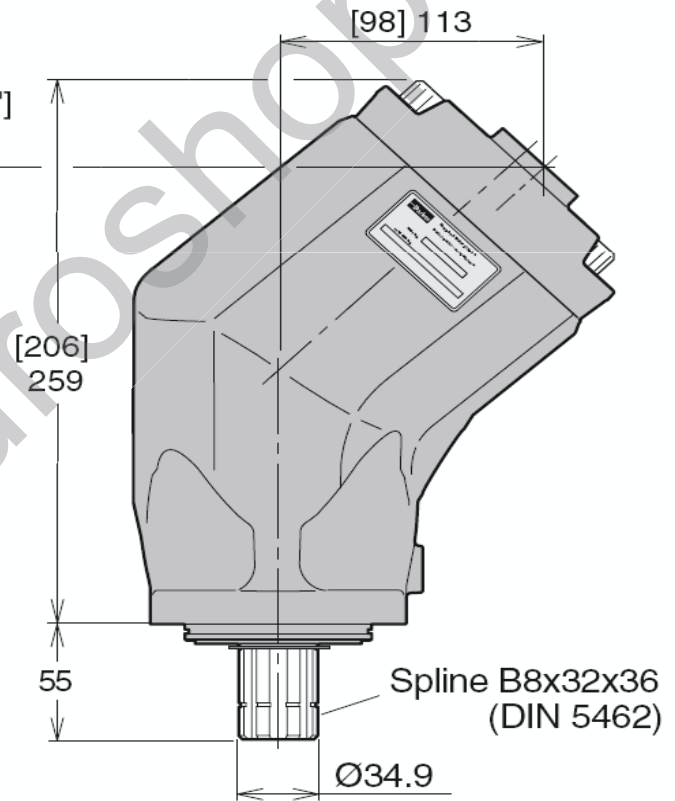
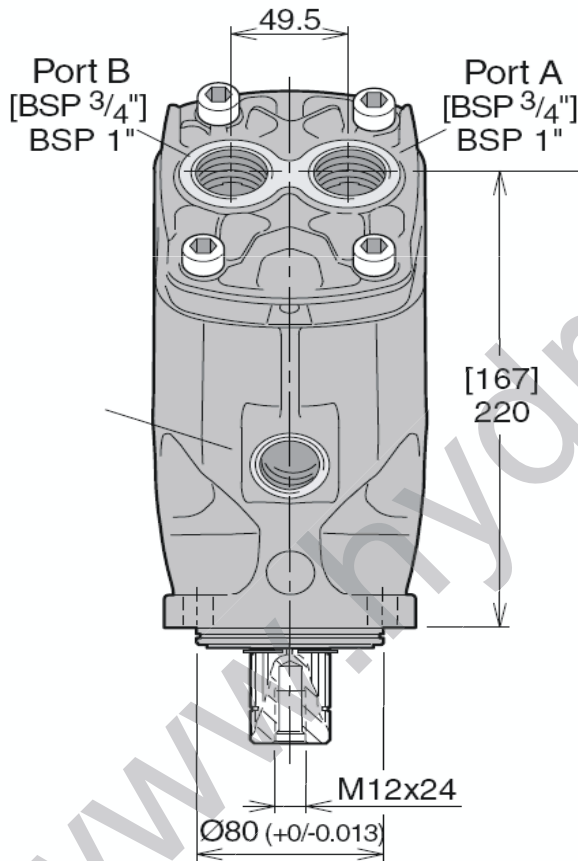

Note ! Drain line must be mounted. Connection BSP 1/2". Maximum drain line pressure is 3 bar

