

RCX 2 AXIS SINGLE LEVER REMOTE CONTROL

Hydraulic remote control RCX belongs to wide range of Hydrocontrol's Remote Control; the lever's anti-swaying system and the ergonomic handle provides great sensitivity while manoeuvring and makes his use very comfortable for the operator. Low operating efforts, low energy consumption and low maintenance make these hydraulic remote controls RCX ideal for piloting remote control directional valves, variable displacement pumps and motors, auxiliary valves, frictions and hydraulic brakes.



TECHNICAL SPECIFICATIONS

Max pressure: **100 bar**

Oil capacity: **12 l/min**

Weight: **2,5 Kg**

APPLICATIONS

Mini-excavators, Mini steer loaders, Backhoe loaders, Wheel loaders, Tractors, Boom mower

DIMENSIONS

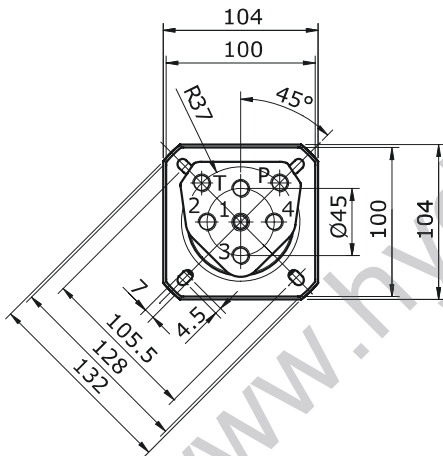

HYDRAULIC SCHEMA

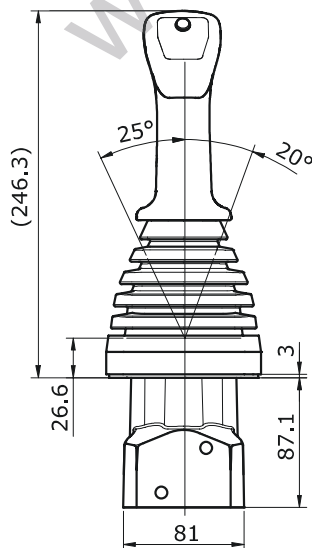
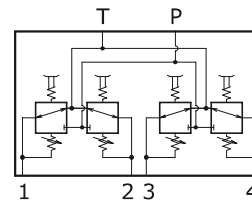

HOLDER HOLE DIMENSION

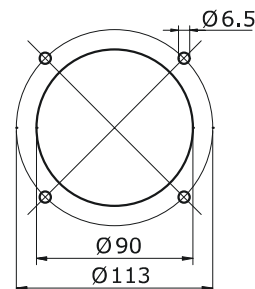

ORDER EXAMPLE = RCX: 03 - A01 - MA - F 05F 00R (2) - WF53 - RA G02

- RCX: product type
- 1 CONTROL CLASSIFICATION:**
 - 03** control type
 - 2 METERING CURVE:**
 - A01** curve type
 - 3 RETURN SPRING:**
 - MA** return spring type
 - 4 HANDLE CLASSIFICATION:**
 - F** handle type
 - 05F** front buttons arrangement
 - 00R** rear buttons arrangement
 - (2)** handle position compared to ports
 - 5 LEVER ROD CLASSIFICATION:**
 - WF** lever rod type
 - 53** lever rod length
 - 6 BODY ARRANGEMENT:**
 - RA** body specification
 - G02** body thread

Ordering row 2 and 3, must be repeated for each port
 complete sample: **RCX: 03 A01 MA A01 MA A01 MA A01 MA F 05F 00R 2 WF53 RA G02**

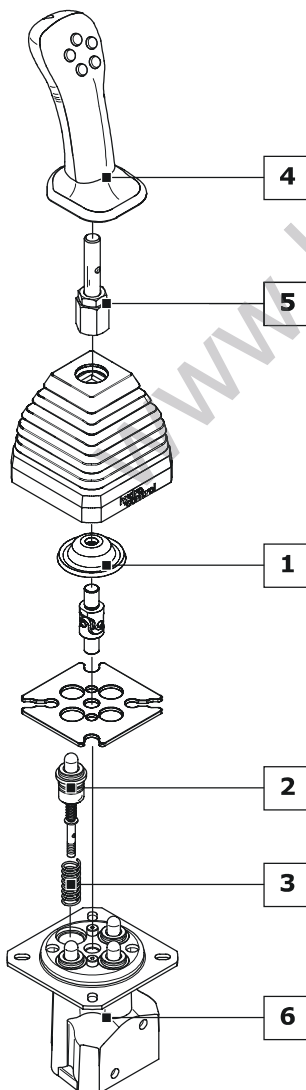

1 CONTROL CLASSIFICATION: (page 12)
01 Return spring in neutral
02 Return spring in neutral with detent in only one service port
03 Return spring in neutral with square bellows for straight lever rod
04 Return spring in neutral with square bellows for bent lever rod
2 METERING CURVE: (page 70)
A01 Linear metering curve with step
B01 Linear metering curve without step
C01 Broken line metering curve with step
D01 Broken line metering curve without step
3 RETURN SPRING: (page 79)
MA Preload 25 N - End stroke load 48 N
MB Preload 14 N - End stroke load 27 N
MC Preload 73 N - End stroke load 135 N
MD Preload 89 N - End stroke load 169 N
4 HANDLE CLASSIFICATION: (page 80)
A Without micro-switch
B With micro-switch to close
D With dual micro-switch
F Ergonomic handle
K Spherical handle
5 LEVER ROD CLASSIFICATION: (page 13)
WF53 Straight standard lever for "F" handle
WG51 Bented standard lever for "F" handle
6 BODY ARRANGEMENT: (page 15)
RA G02 Standard Body (G 1/4 ports)
RB G02 Body with shuttle valve for translation (G 1/4 ports)

CONTROL KIT CLASSIFICATION

All controls installed on the remote control RCX are interchangeable. Lever rod type must be chosen according to different control kit (see quick reference guide pag.13-14). The controls shown correspond to standard configurations; for different applications contact our Commercial Dept.

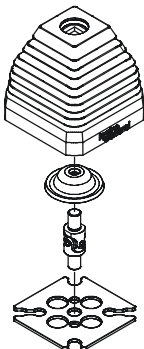
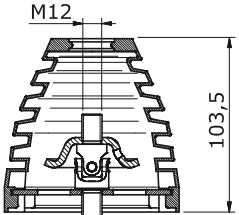
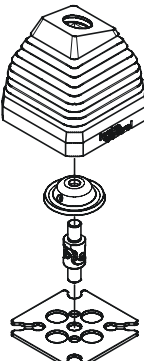
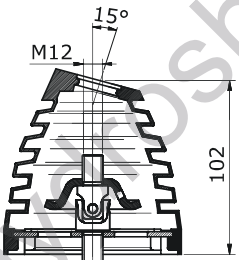
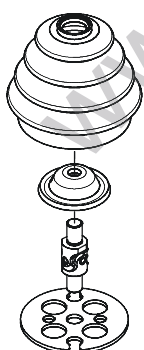
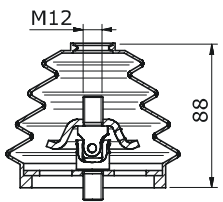
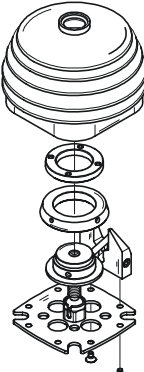
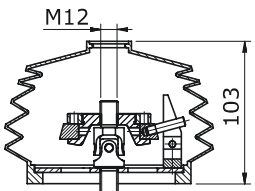
Code	Configuration	Dimensions	Description
03			Return spring in neutral with square bellows for straight lever rod
04			Return spring in neutral with square bellows for bent lever rod
01			Return spring in neutral with round bellows
02			Return spring in neutral with detent in only one service port NOTE: user port where to apply mechanical detent must be specified

LEVER ROD CLASSIFICATION

The lever rod kits applied to all the RCX hydraulic remote controls designed by Hydrocontrol change according to the type of control used and, above all, the type of handle. For improved clarity, all the possible lever rod configurations divided according to handle are listed here below. Straight and curved lever rods are available in several lengths and dimensions.

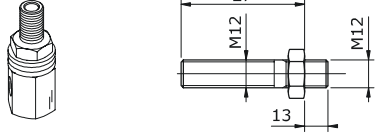
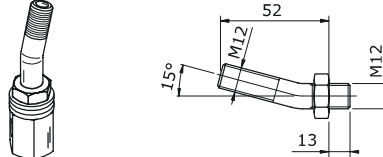
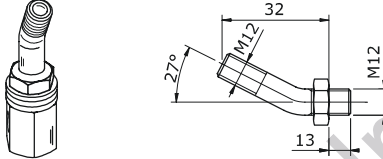
IDENTIFICATION ROD LEVER HANDLE "A-B-C-D" - QUICK REFERENCE GUIDE					
Code	Dimensional drawing	Control 01	Control 02	Control 03	Control 04
WA27		•	•		
WB52		•	•		
WD32		•		•	

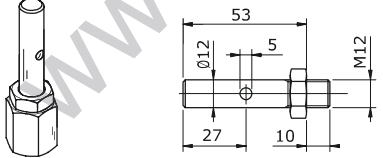
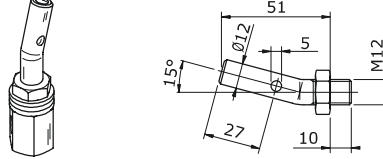
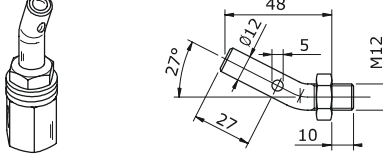
IDENTIFICATION ROD LEVER HANDLE "F" - QUICK REFERENCE GUIDE					
Code	Dimensional drawing	Control 01	Control 02	Control 03	Control 04
WF53		•	•	•	
WG51		•	•		•
WH48		•	•		•



RCX 2 AXIS SINGLE LEVER REMOTE CONTROL

IDENTIFICATION ROD LEVER HANDLE "K" - QUICK REFERENCE GUIDE

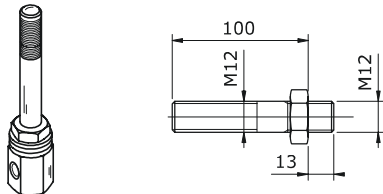
Code	Dimensional drawing	Control 01	Control 02	Control 03	Control 04
WE100		•	•		

IDENTIFICATION ROD LEVER HANDLE "S" - QUICK REFERENCE GUIDE

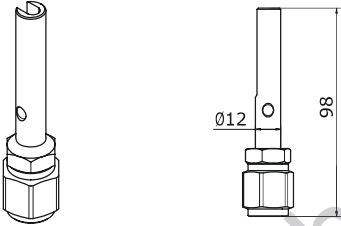
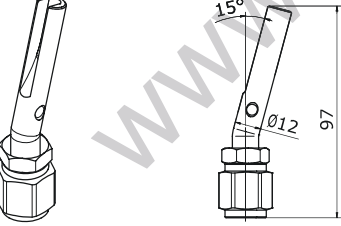
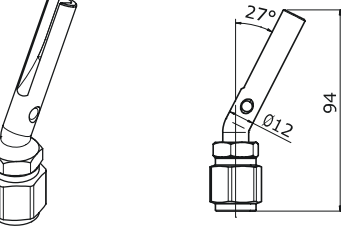
Code	Dimensional drawing	Control 01	Control 02	Control 03	Control 04
WS76		•	•	•	
WT69		•		•	•
WU65		•		•	•

BODY ARRANGEMENT

The remote hydraulic RCX body has two versions: standard body and body with shuttle valve for translation. The set-up for translation applications (code: RB) includes a flanged plate with internal shuttle valves allowing a single service port control to be split between two ports. In this way, action on the lever will generate two separate pressure signals, allowing dedicated machine translation devices to be controlled.

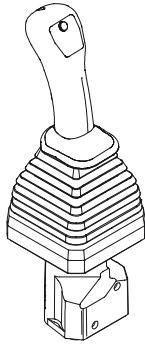
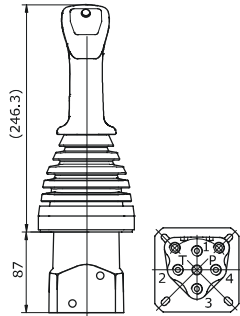
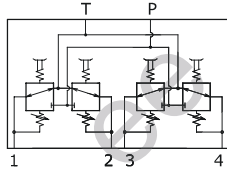
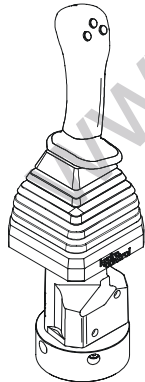
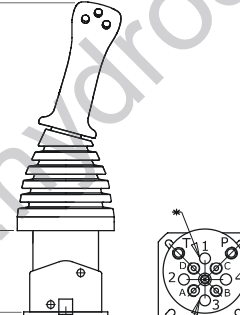
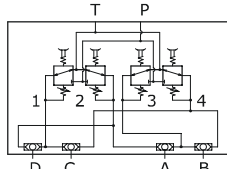
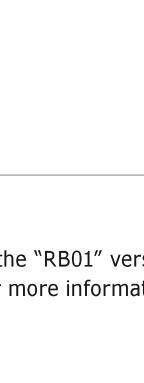
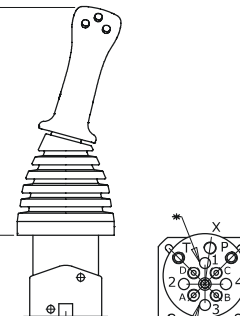
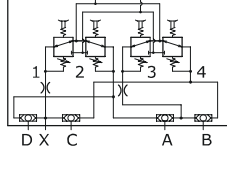
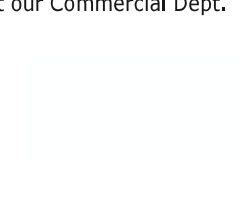
Code	Configuration	Dimensions	Schema	Description
RA G02				Standard body with ports G 1/4
RA U02				Standard body with ports 9/16" - 18 UNF
RB G02				Body with shuttle valve for translation with ports G 1/4
RB U02				Body with shuttle valve for translation with ports 9/16" - 18 UNF
RB01 G02				Body with shuttle valve for translation with auxiliary port (X) for Alert with ports G 1/4
RB01 U02			 (*) Chokes Ø 2 mm on ports 1 - 3	Body with shuttle valve for translation with auxiliary port (X) for Alert with ports 9/16" - 18 UNF

As an alternative to the "RB01" version, other set-ups are available with different flow restrictor diameters and configurations on the service ports; for more information contact our Commercial Dept.