

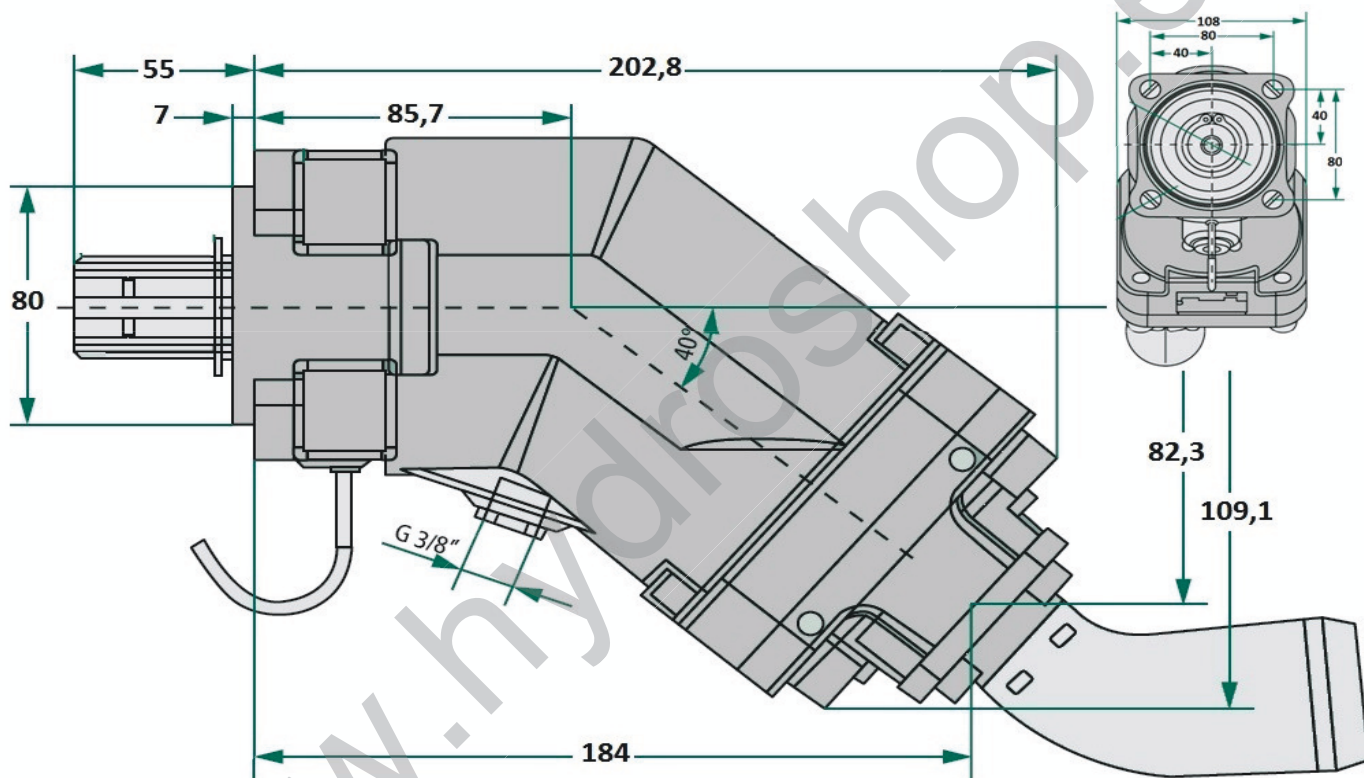

XP 41 kolbpump, PTO võll

Tootlikkus cm³/pöörde kohta	V_g	41cc
Maksimum töösurve		bar
Nominaal		350
Lühiajaline 5 sek intervalliga 1 min		400
Maksimum pöörlemise kiirus		bar p/min
imitoru 2"	350	2500
Maksimum Nm		bar Nm
	350	243
Pöörlemise suund		R / L
Kaal kg		11,2



XPI 41

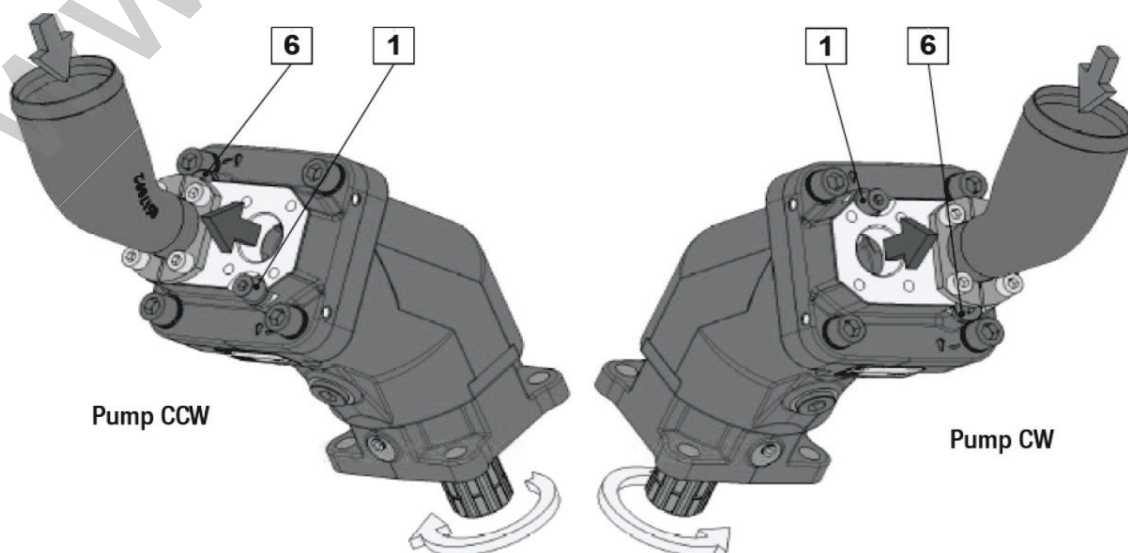

Pump CCW

Pump CW

